

Product Specification

- ◇ PRELIMINARY SPECIFICATION
- ◆ APPROVED SPECIFICATION

Part Number: FLD-070DMLK1PCSA2

Description : TFT 7''W, 800(H)*480(V), Full Viewing Angle , LVDS 8 bit,
1000CD Assembled Rocktouch Pcap 3.0mm Black Combo USB /I2C

Prepared by : Natalie

Approved by : David

Confidential

Prepared by	Reviewed by	Date
Natalie	David	2020/2/01

Revision History

Version	Date	Page	Description	Note
V1.0	2019/09/23		1 st Release	
V2.0	2019/11/13		Modify driving current, PWM frequency / adjust range and PINOUT	P6/7, P12/13, P18
V3.0	2020/02/01		Update	

Confidential



Table of Content

Product Specification.....	1
A. TFT Specification	4
1. GENERAL DESCRIPTION.....	4
1.1 Description.....	4
1.2 Product Summary	4
2. ABSOLUTE MAXIMUM RATING.....	5
2.1 Electrical Absolute Rating	5
2.2 Environment Absolute Rating	5
3. ELECTRICAL CHARACTERISTICS.....	6
3.1 TFT LCD.....	6
3.3 BACK LIGHT.....	7
3.3.1 ELECTRICAL CHARACTERISTICS	7
4. SIGNAL CHARACTERISTICS.....	8
4.1 LCD Interface Timing.....	8
4.2 Timing Chart	9
4.2.1 Input clock and data timing diagram	9
4.2.2 Data Input Format	10
4.2.3 Power Sequence.....	11
5. INTERFACE PIN DESCRIPTION	12
6. BLOCK DIAGRAM	14
7. OPTICAL CHARACTERISTIC.....	15
B. Touch Screen specification	18
1. Environmental Specification.....	18
2. Mechanical Specification	18
3. COMBO Type Controller USB / I2C	18
C. Outline dimension	19
D. PRECAUTION AND PRODUCT HANDLING.....	20

Confidential



A. TFT Specification

1. GENERAL DESCRIPTION

1.1 Description

7 inch is a Color Active Matrix Liquid Crystal Display Module composed of a TFT LCD panel and LED backlight system. The screen format is intended to support the 800(H) x480(V) screen and 16.7M colors.

1.2 Product Summary

The following items are summary on the table under Ta=25 °C condition:

No.	Item	Specification	Unit
1	Display Size	7.0	Inch
2	Pixel Number	800(H) x (R,G,B) x 480(V)	Pixels
3	Outline Dimension	193(H) x 136(V) x 15Max.(D)	mm
4	Active Area	152.4 (H) x 91.44 (V)	mm
5	Pixel Pitch	0.1905(H) x 0.1905(V)	mm
6	Display Colors	16.7M	--
7	Display Format	RGB vertical stripe	--
8	Display Mode	Normally Black	--
9	Electrical Interface	1-ch LVDS	
10	Surface Treatment	Anti-Glare, Hard-Coating (3H)	--
11	Brightness	1000 (central) (Typ)	cd/m2
12	Contrast Ratio	1000 (Typ.)	--
13	Consumption of Power	LCM: 0.55 Backlight: 4	W
14	Module Weight	180	g

2. ABSOLUTE MAXIMUM RATING

2.1 Electrical Absolute Rating

Item	Symbol	Values		Unit	Remark
		Min	Max		
Power Voltage	Vcc	-	4.5	V	
	VLED	9	13.5	V	
Backlight Adjust	LED_PWM	-	3.6	V	
Enable Voltage	LED_EN	-	3.6	V	

Note 1. Permanent damage may occur to the LCD module if beyond this specification. Functional operation should be restricted to the conditions described under normal operating conditions.

Note 2. Ta= 25±2°C

2.2 Environment Absolute Rating

Item	Symbol	Values		Unit	Remark
		Min	Max.		
Operating Temperature	Top	-30	80	°C	
Storage Temperature	Tstg	-40	95	°C	



3. ELECTRICAL CHARACTERISTICS

3.1 TFT LCD

ITEM	SYMBOL	MIN	TYP	MAX	UNIT	NOTE
Supply Voltage	Vcc	3.0	3.3	3.6	V	
Input signal voltage	ViH	0.7*Vcc	-	Vcc	V	
	ViL	0	-	0.3*Vcc	V	
Current of power supply	Icc	-	130	-	mA	Vcc=3.3V White pattern
Differential voltage	VID	VID /2				
Differential Input Commo mode voltage	RxVCM	VID /2				

Confidential



3.3 BACK LIGHT

3.3.1 ELECTRICAL CHARACTERISTICS

Ta=25°C

ITEM	SYMBOL	CONDITIONS	MIN	TYP	MAX	UNIT
LED voltage	VLED	Ta=25°C	10.2	12	13.5	V
Power Consumption					4	W
LED enable Input Low Level			-	-	0.3	V
LED enable Input High Level			2	3,3	-	V
Adjust PWM control Ratio			3	-	100	%
PWM Input Frequency			250	500	20,000	Hz
LED Lifetime	N/A	Ta=25°C	-	40000		Hr

Note (1) LED life time (Hr) can be defined as the time in which it continues to operate under the condition: Ta=25±3 °C,

Note (2) The “LED life time” is defined as the module brightness decrease to 50% original brightness at Ta=25°C.



4. SIGNAL CHARACTERISTICS

4.1 LCD Interface Timing

Item	Symbol	Min.	Typ.	Max.	Unit	Note
DCLK cycle time	Tcph	20		220	ns	
DCLK pulse duty	Tcwh	35	50	65	%	
Data setup time	Tdsu	8			ns	
Data hold time	Tdhd	8			ns	
DE setup time	Tesu	8			ns	
DE hold time	Tehd	8			ns	
DCLK frequency	Fclk	28	30	32	MHz	
Horizontal display area	Thd	800			Tcph	
HSD period time	Th	899	902	915	Tcph	
HSD pulse width	Thpw	5	10	15	Tcph	
HSD back porch	Thb	32			Tcph	
HSD front porch	Thfp	52	60	68	Tcph	
Vertical display area	Tvd	480			th	
VSD period time	Tv	546	555	564	th	
VSD pulse width	Tvpw	6	10	14	Th	
VSD back porch	Tvb	5			th	
VSD front porch	Tvfp	55	60	65	th	

4.2 Timing Chart

4.2.1 Input clock and data timing diagram

DE mode

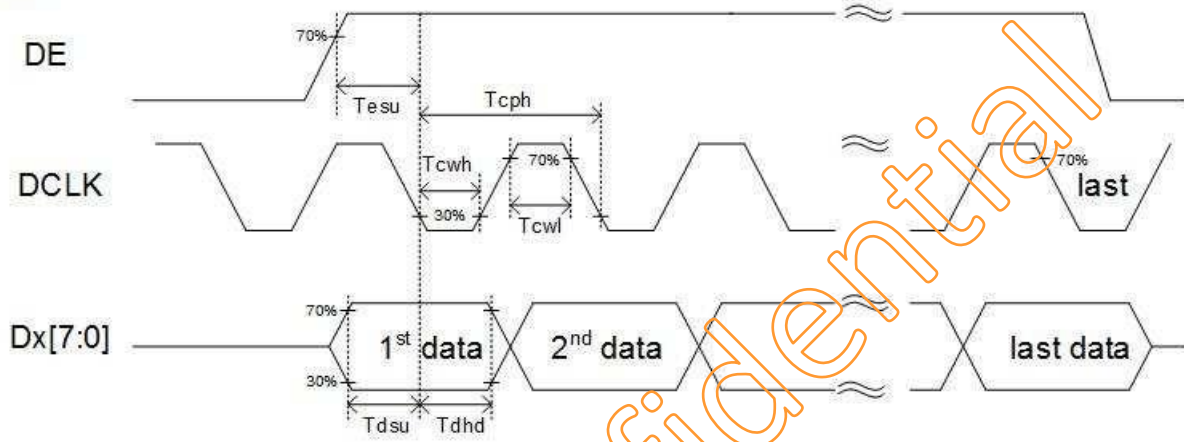

4.2.2 Data Input Format

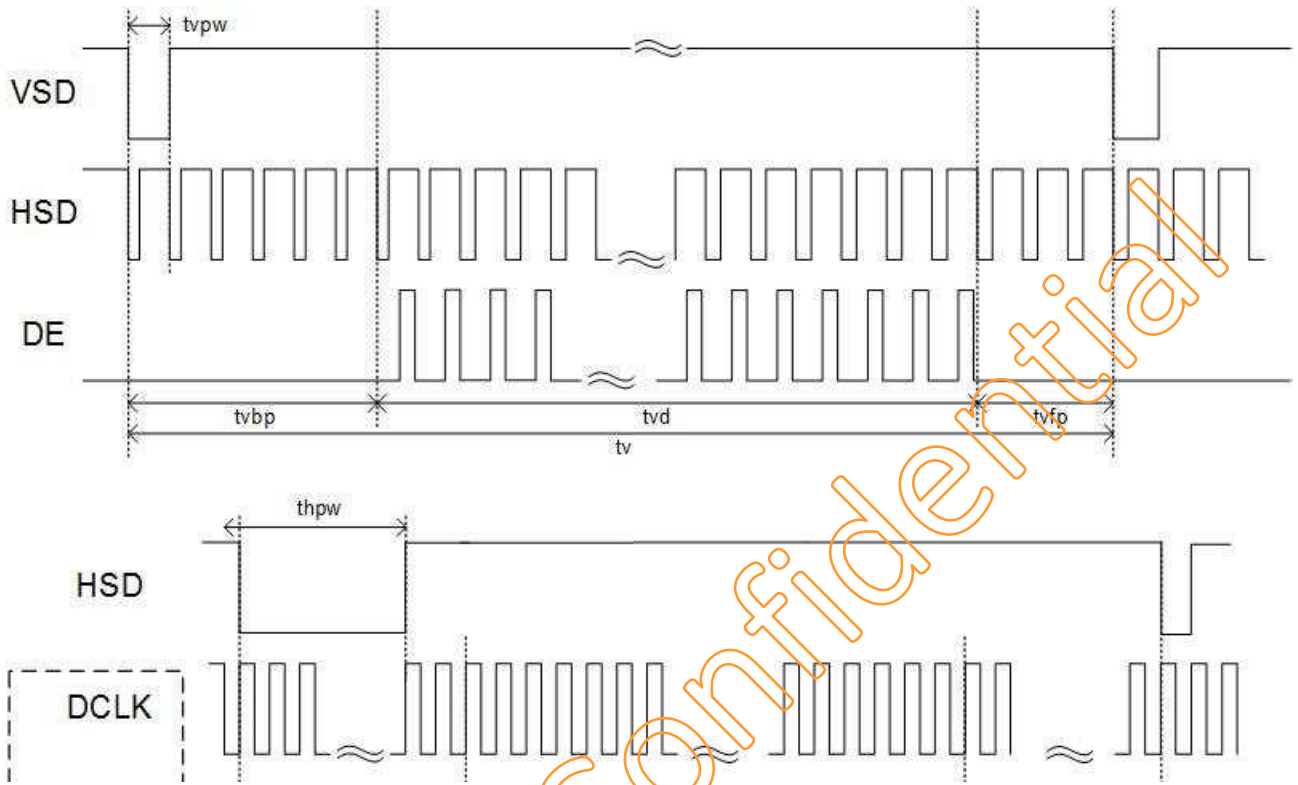

4.2.3 Power Sequence

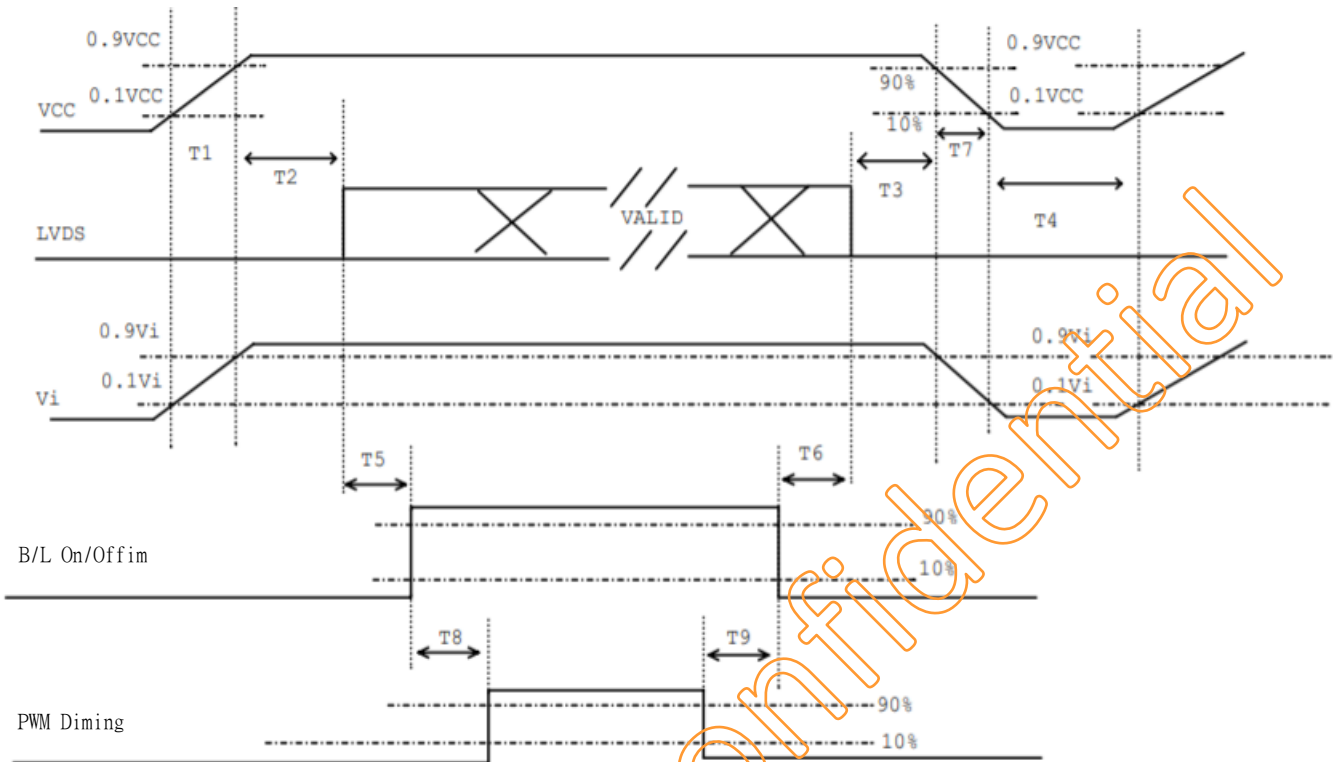

Parameter	Value			Units
	Min	Typ	Max	
T1	0.5	-	10	ms
T2	0	-	50	ms
T3	0	-	50	ms
T4	500	-	-	ms
T5	-	-	-	ms
T6	-	-	-	ms
T7	-	-	-	ms
T8	-	-	-	ms
T9	-	-	-	ms

5. INTERFACE PIN DESCRIPTION

Connector: 093G30-00001A-M4)

PIN no.	Symbol	Description
1	VCC LCD	Power Supply Voltage (+3.3V)
2	VCC LCD	Power Supply Voltage (+3.3V)
3	NC	No Connection
4	RX0-	LVDS Differential Data Input
5	RX0+	LVDS Differential Data Input
6	RX1-	LVDS Differential Data Input
7	RX1+	LVDS Differential Data Input
8	RX2-	LVDS Differential Data Input
9	RX2+	LVDS Differential Data Input
10	GND	Ground
11	RXCLK-	LVDS differential Clock Input
12	RXCLK+	LVDS differential Clock Input
13	RX3-	LVDS Differential Data Input
14	RX3+	LVDS Differential Data Input
15	GND	Ground
16	V rotation	Reverse Scan Up/Down (Note)
17	H rotation	Reverse Scan Left/Right (Note)
18	NC	No Connection
19	NC	No Connection
20	NC	No Connection
21	NC	No Connection
22	GND	Ground
23	NC	No Connection
24	NC	No Connection
25	NC	No Connection
26	NC	No Connection
27	BLK VCC	LED power supply (12V)
28	BLK VCC	LED power supply (12V)
29	ENABLE	Backlight Enable
30	PWM	PWM mode

Note:

SHLR	UPDN	Data shifting
H	H	Left →Right, Up →Down
L	H	Right →Left, Up →Down
L	L	Right →Left, Down →Up
H	L	Left →Right, Down →Up

Confidential



6. BLOCK DIAGRAM

The following diagram shows the functional block of the TFT module:

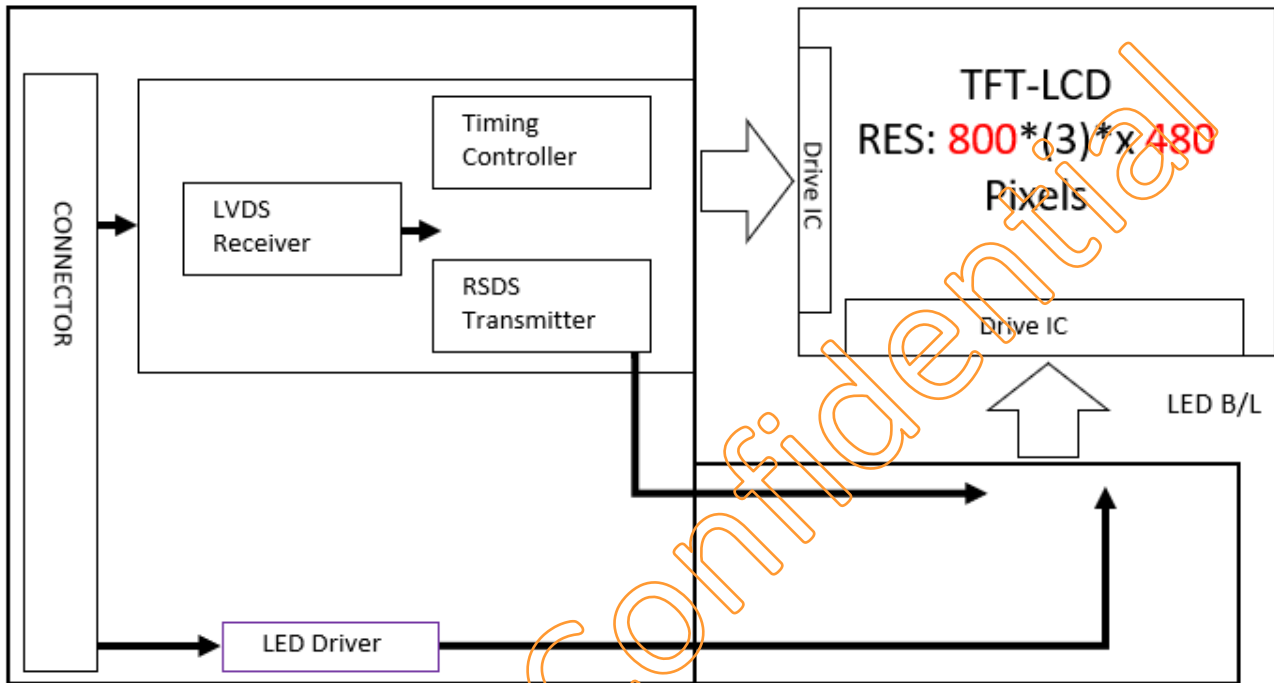

7. OPTICAL CHARACTERISTIC

The optical characteristics are measured under stable conditions at room temperature.

Parameter		Symbol	Condition	Min.	Typ.	Max.	Unit	Remarks
Viewing Angle	Horizontal	θ_{x+}	Center $CR \geq 10$	80	85	--	Deg.	
		θ_{x-}		80	85	--		
	Vertical	θ_{Y+}		80	85	--		
		θ_{Y-}		80	85	--		
Contrast Ratio		CR	$\theta_x = \theta_y = 0^\circ$	700	1000	--		Note 1,2
Response time		Rising +Falling	Center $\theta_x = \theta_y = 0^\circ$	--	30	40	ms	Note 5
Uniformity (9P)		YU	$\theta_x = \theta_y = 0^\circ$	70	80	--	%	Note 1,3
Brightness		L	$\theta_x = \theta_y = 0^\circ$	750	1000	--	cd/m ²	Note 1
Chromaticity	xW	Center $\theta_x = \theta_y = 0^\circ$	-0.04	+0.04	0.31			Note 1,2
	yW				0.33			
	xR				0.650			
	y R				0.334			
	xG				0.292			
	y G				0.611			
	xB				0.147			
	y B				0.061			

The following optical specifications shall be measured in a darkroom or equivalent state (ambient luminance ≤ 1 lux, and at room temperature).

The operation temperature is $25^\circ\text{C} \pm 2^\circ\text{C}$

Note 1: The method of optical measurement

The LCD module should be turn-on to a stable luminance level to be reached. The measurement should be executed after lighting Backlight for 20 minutes and in a dark room.

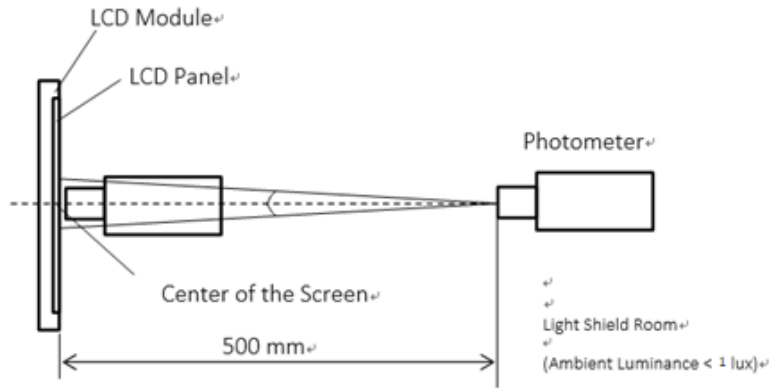

Note 2: Definition of Contrast Ratio

Measure the viewing angle of $\Theta = 0$ and at the center of the LCD surface. Luminance with all pixels in white state divide by Luminance with all pixels in Black state

Note 3: Definition of Luminance and Luminance uniformity

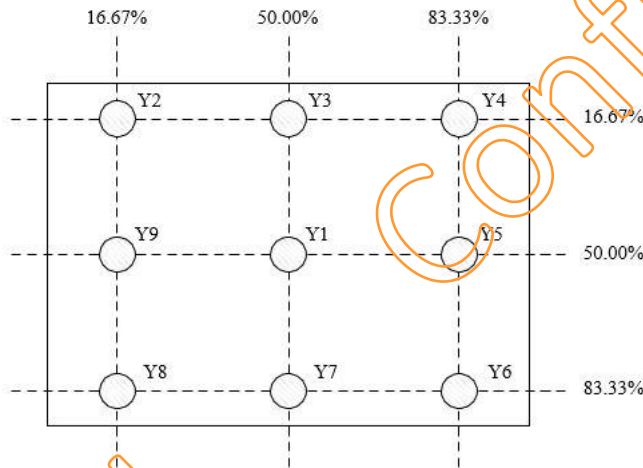

Minimum luminance values of 9 points divide by Maximum luminance of 9 points.

Note 4. Definition of view angle

Viewing angle is the angle at which the contrast ratio is greater than 10. The viewing angles are determined for the horizontal or the vertical clock direction with respect to the optical axis which is normal to the LCD surface.

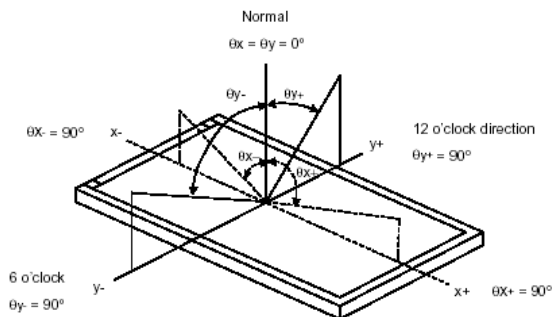

Note 5. Definition of Response time

The response time is set initially by defining the “Rising Time (Tr)” and the “Falling Time (Tf)” respectively. The response time interval is between 10% and 90% of amplitudes, please refer the figure to the followings:

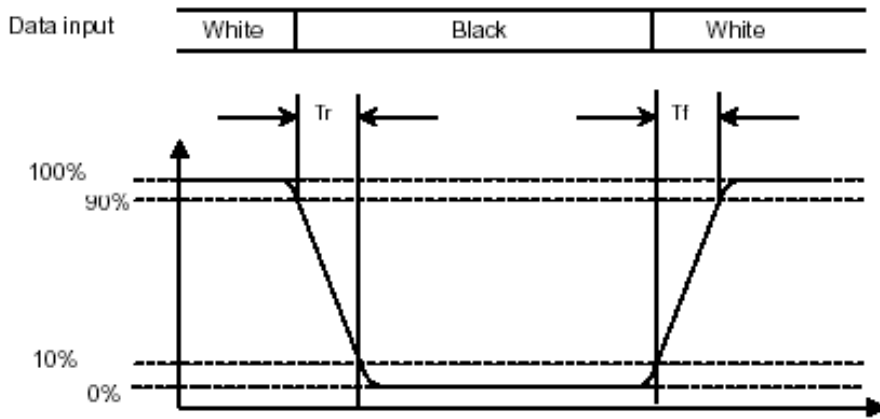

Note 6: Crosstalk Modulation Ratio

$$CT = (Y_B - Y_A) / Y_A \times 100\%$$

YA、YB measure position and definition

YA means luminance at gray level 128(exclude gray level 0 pattern)

YB means luminance at gray level 128(include gray level 0 pattern)

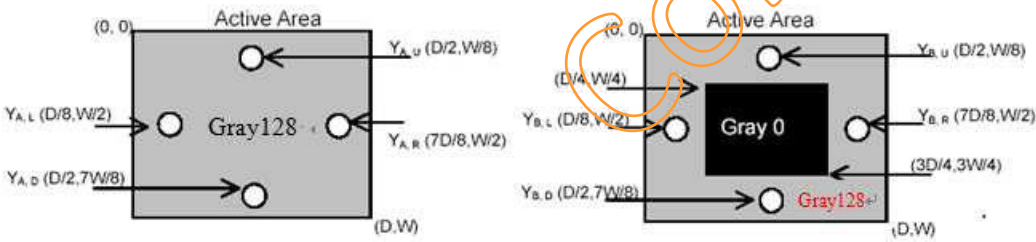

B. Touch Screen specification

1. Environmental Specification

Specification	Value	Remarks
Operating Temperature	-30°C ~ 80°C	
Storage Temperature	-40°C ~ 80°C	
Operating Humidity	20% ~ 90%RH	
Storage Humidity	10% ~ 90%RH	

2. Mechanical Specification

Specification	Value
Operating Life (Finger input)	10 ⁷ times
Light Transmittance	>86% Min. (JIS K-7105) with glass
Surface hardness	Depending by the cover Lens Material Customer choose
FPC Peeling Force	5N Max

3. COMBO Type Controller USB / I2C

Parameters	Features
Circuit Board Dimension	Refer to drawings
Channels of Panel	Based on Sensor Design
Input Voltage	3.5V~5.5V Typical 5V for USB suggest to use 5V for I2C too
Linearity(Note 1)	Single Line drawing accuracy : Up to 1pt +/- 1mm offset /10mm Single Touch (point) accuracy : Up to 1pt +/- 1mm
Interface	USB: 2.0(Below) Full Speed I2C:100K/400K Hz
Resolution	4096×4096 resolution
Power consumption(mA)	Active Mode: <40mA
	Idle Mode : <30mA
	Sleep Mode :< 10mA
	(Operation Mode :Active Mode only)
Report rate(points/sec) Note(2)	> 100 Hz
Response time	Average < 25 ms

Note (1): Depending by Sensor design and other parameters, Refer to Windows 8 Logo regulation if need to follow min spec

Note (2): Report rate will vary by channel number, cover thickness, number of fingers and other parameters

C. Outline dimension

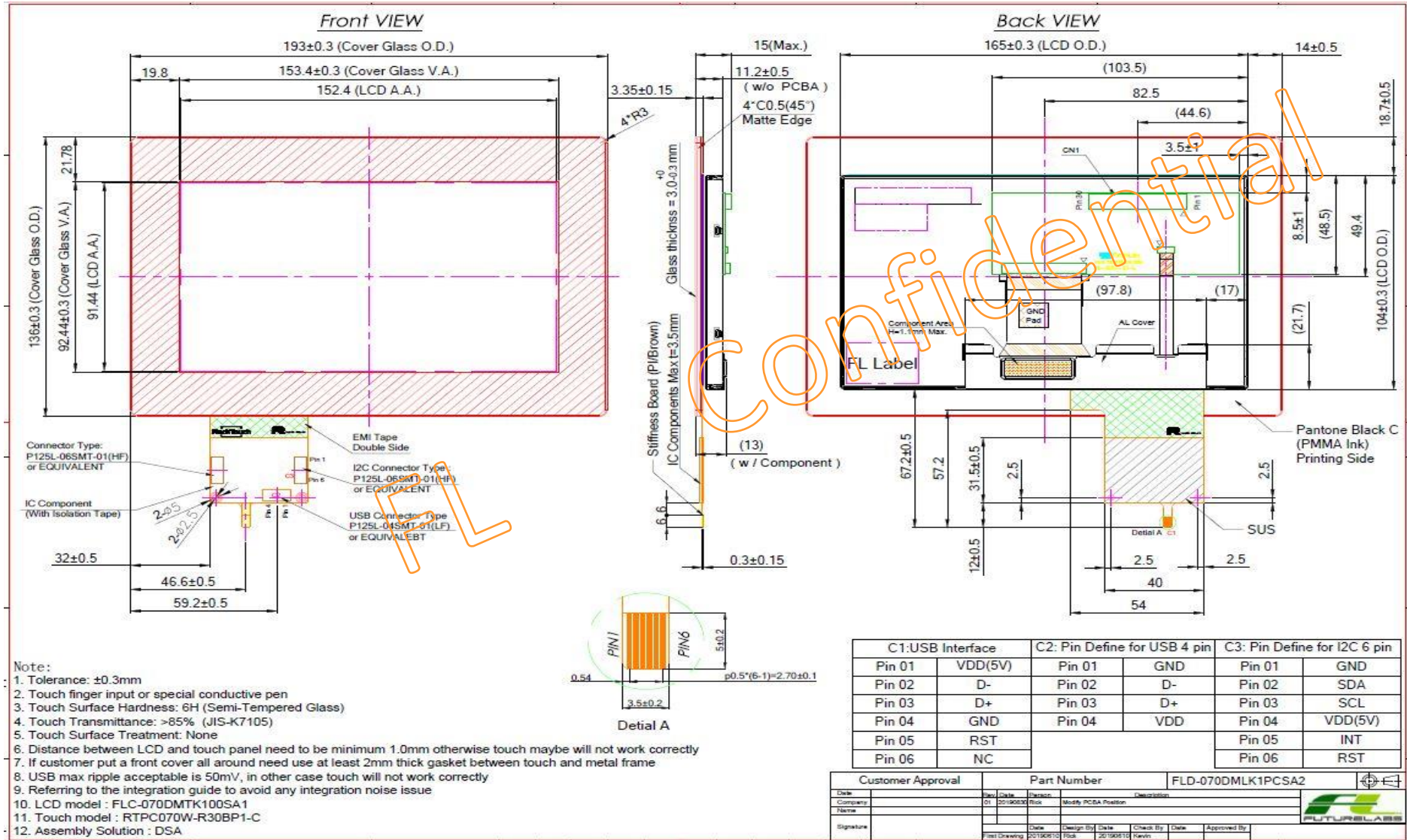

D. PRECAUTION AND PRODUCT HANDLING

- Do not apply the external force such as bending or twisting to the LCD panel and backlight during assembly.
- Do not insert and plug out the input connector while the LCD panel is operating.
- Do not take apart the panel or frame from LCD module assembly or insert anything into the backlight unit.
- Do not keep the same pattern in a long period of time, it may cause image sticking on LCD panel. Can use shuffle content periodically if fixed pattern is displayed on the screen.
- Do not touch the display area with bare hands, this will stain the display area.
- Pay attention to handle lead wire of backlight, that is not tugged in connect with LED driver.
- Do not change variable resistance settings in LCD panel, it may cause not satisfy of LCD characteristics specification.
- The surface of LCD panel's polarizer is very soft and easily scratched, please use a very soft dry cloth without chemicals for cleaning.
- To avoid the static electricity to damage the CMOS LSI, the operator should be grounded when in contact with the LCD panel, and also to all electrical equipment.
- Need to follow the correct power frequency when LCD panel is connecting and operating, this can avoid damage to CMOS LSI during latch-up.
- Need to store the LCD panel indoor without the exposure of sunlight where the temperature is $25^{\circ}\text{C} \pm 5^{\circ}\text{C}$ and the humidity is below 60% RH.

